

JEDNOLŮŽKO ZVÝŠENÉ

974x995x2060

č. 260/BC

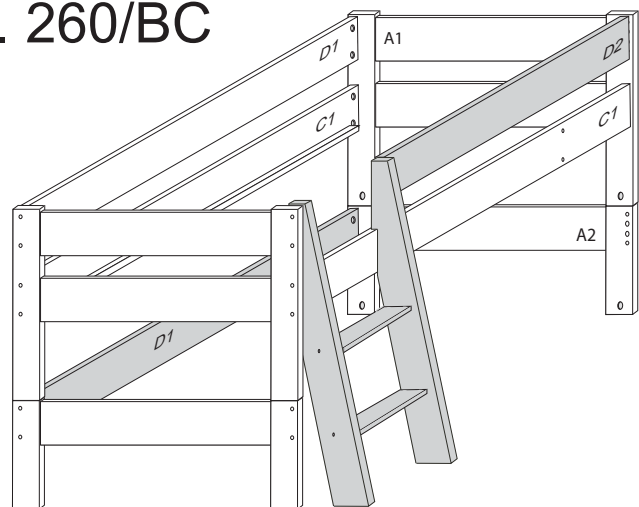

Kolíky vždy narazte nejprve do otvorů ve hranách dílců, je nutné je zarazit se stejným přesahem. V případě, že některý kolík přesahuje, je nutné jej zakrátit. Dílce srážejte kladivem pouze přes dřevěnou podložku.

V případě vrzání vtačte do spoje tekuté mýdlo v poměru 1:1 s vodou. Tento jev se u nábytku z masivu vyskytuje běžně.

1/3

	1 x1	4 x1	5 x1	9 x16	12 x8	29 x16	
		č.4	č.5	10x50mm	6x80mm	4x40mm	
37 x4	38 x2	43a x4	43b x2	45 x4	47 x4	72 x6	87 x6
5x30mm	5x60mm	6x60mm	6x12mm	8x125mm	13.601	7x70mm	
88 x8	89 x4	90 x4				109 x2	110 x2
7mm	10mm	25mm					10x50mm

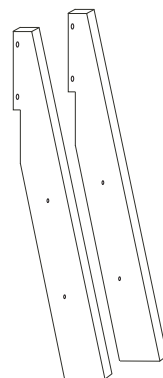
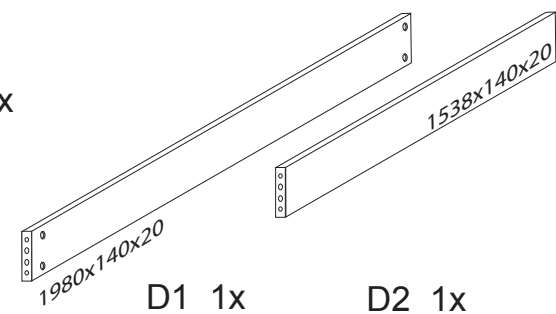
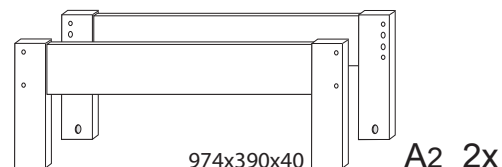

E 2x 1038x110x25

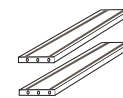

F 2x 392x85x25

260

1

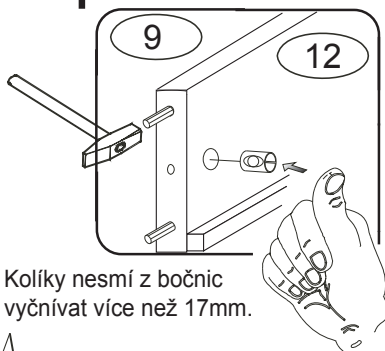

Kolíky nesmí z bočnic
vyčnívat více než 17mm.

2

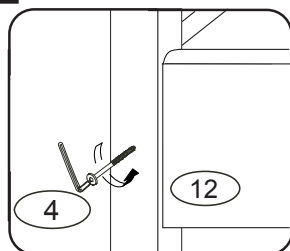

Pokud jdou šrouby obtížně
dotáhnout, tak **NEDOTAHUJTE**,
nejprve zakračte kolíky v bočnicích

3

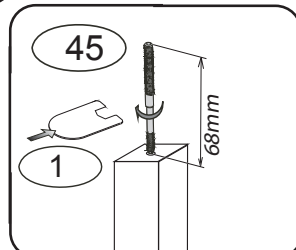

pro snazší zašroubování
nanažte šroub mýdlem
nebo olejem

4

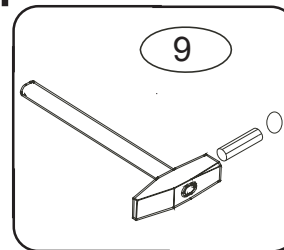

5

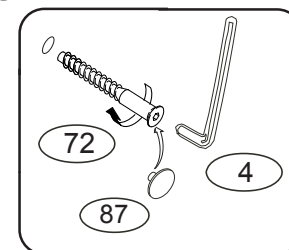

2/3

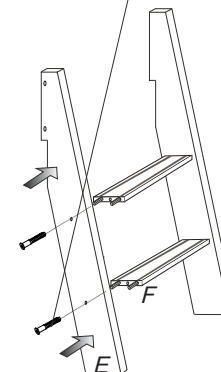
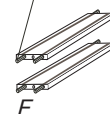
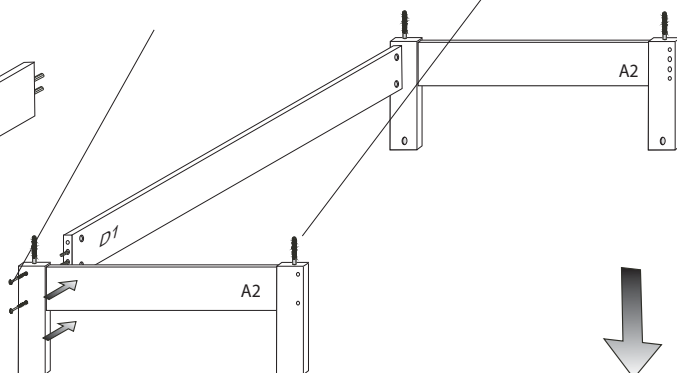
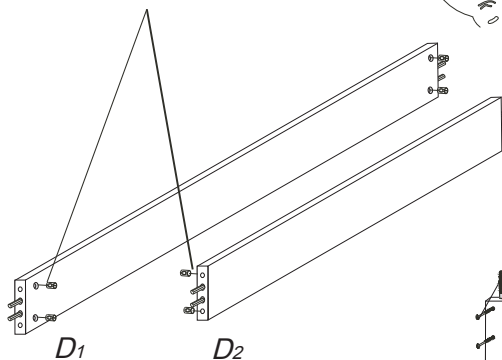

6

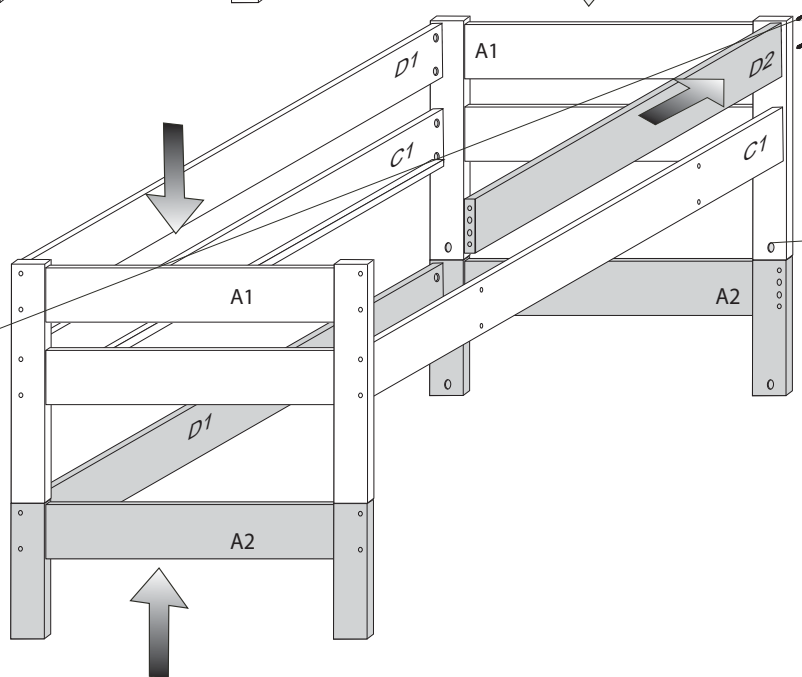
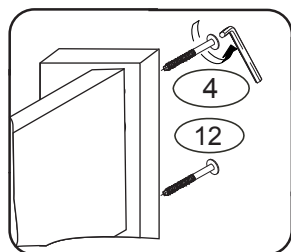

7

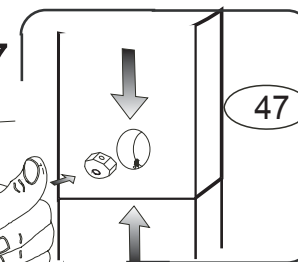

8

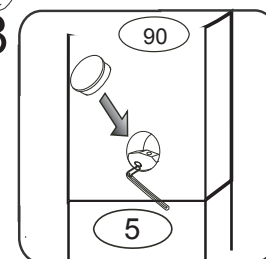

9

10

11

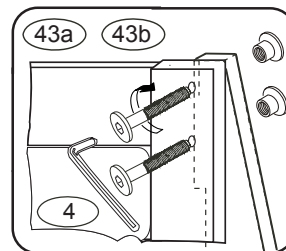
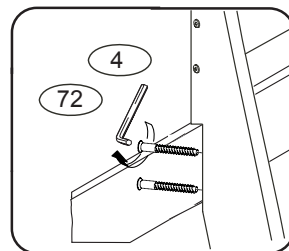
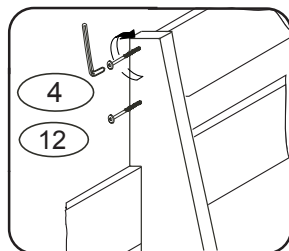

15

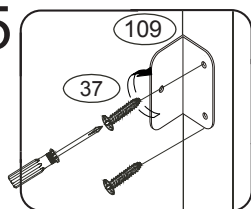

16

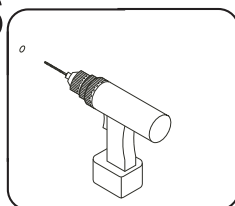

17

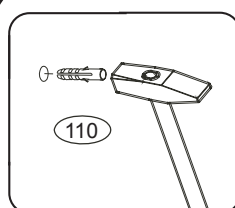

18

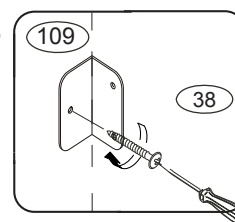

12

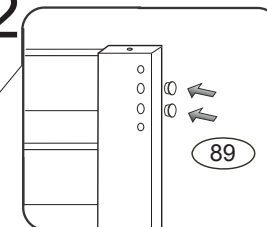

13

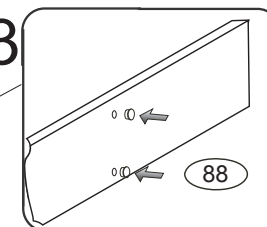

14

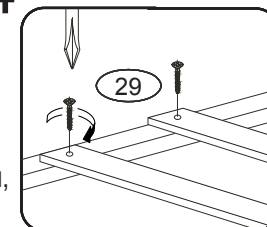

Přišroubujte rošty.
Poslední laťku roštu
přišroubujte co nejbliže k čelu,
aby se zabránilo prošlápnutí.

POKYNY !

- Uvědomte si nebezpečí pádu malých dětí (do 6 let) z horní postele.
- Horní plocha matrace nesmí přesáhnout červenou rysku na stojně zábrany.
- Maximální výška matrace pro horní lůžko je 210mm.
- Bezpečnostní požadavky dle normy ČSN EN 747-1