

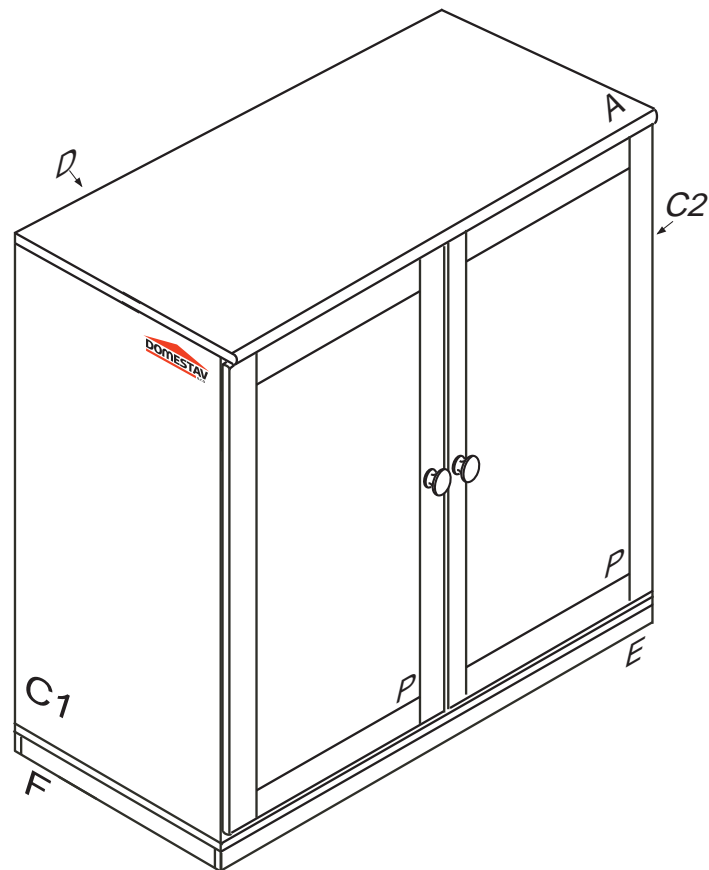

















# VARIO

## K 810-BC

900x340x890

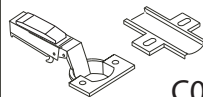

 Kolíky vždy narazte nejprve do otvorů ve hranách dílců, je nutné je zarazit se stejným přesahem. V případě, že některý kolík přesahuje, je nutné jej zakrátit. Dílce srážejte kladivem pouze přes dřevěnou podložku.

	4 x1  4mm	6 x20  8x35mm	22 x8  3,5x16mm	24 x8  4x30mm	
28 x2  M4x30mm	29 x10  4x40mm	43 x8  EU 6x16mm	60 x10  15mm	61 x10  DU 2	67 x6 
71 x6  7x50mm	76  C01	75 x4 	85 x8 	92 x30  1,4x20mm	102 x2 