

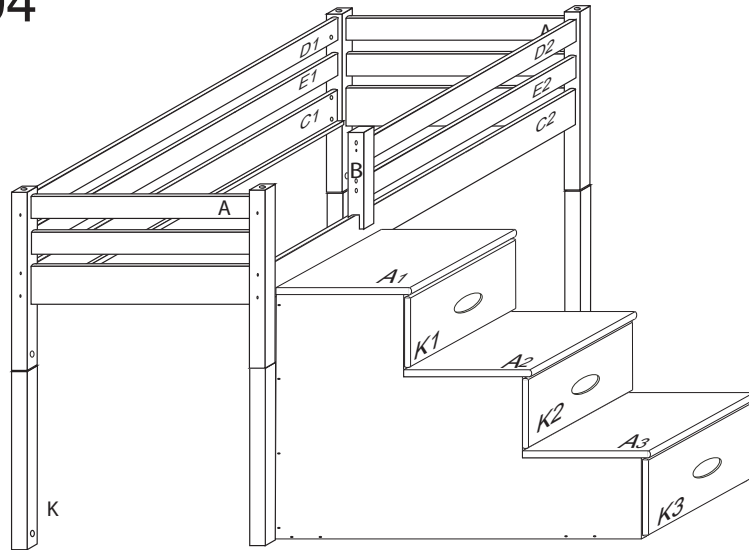

















# DOMINO

č. D 104



	3 x1  č.3	4 x1  č.4	6 x54  8x35mm	21 x8  3x16mm	22 x12  3,5x16mm	23 x10  3,5x12mm
27 x4  4x30mm	60 x1  15mm	61 x13  DU 2	68 x12  12mm	70 x39  5x40mm	71 x16  7x50mm	87 x16 
80+81 x1  300mm	82+83 x1  600mm				96 x4 	

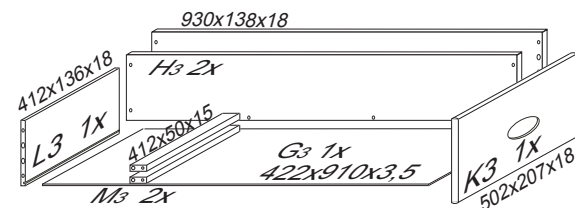
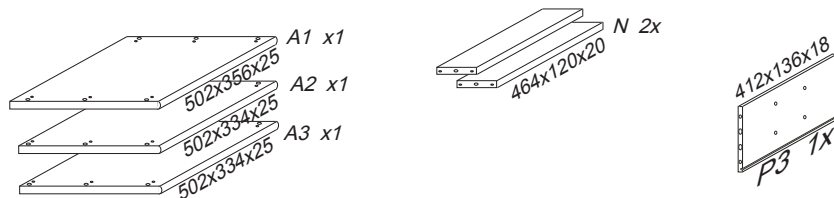
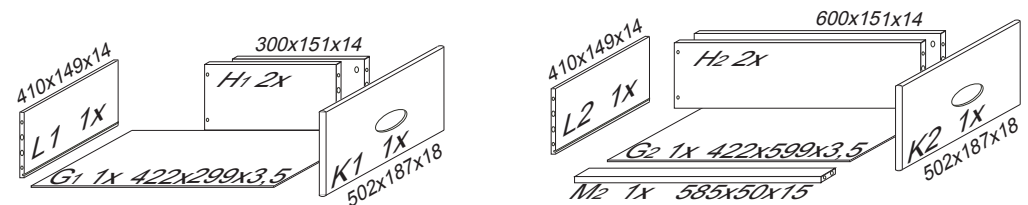
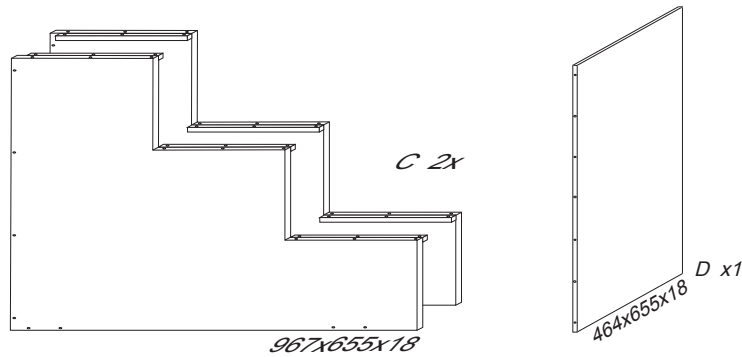
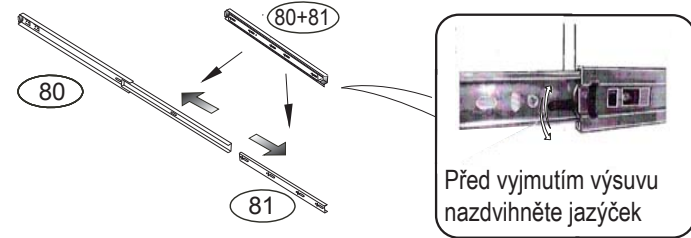

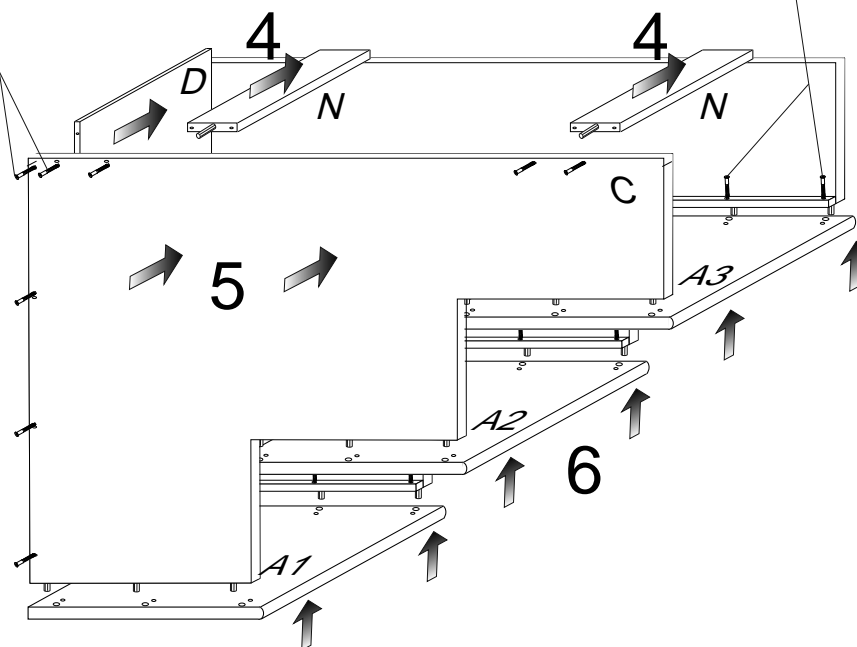
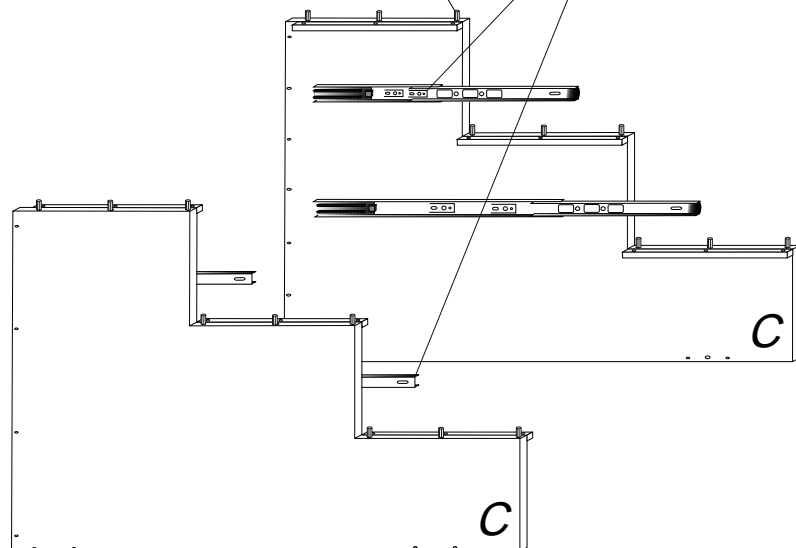
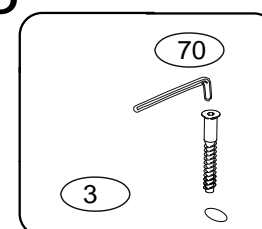
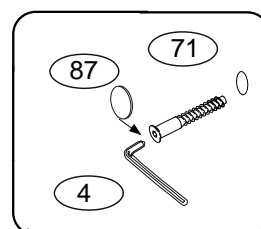
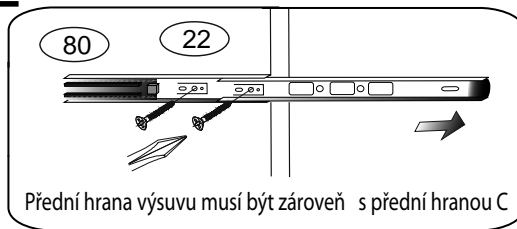
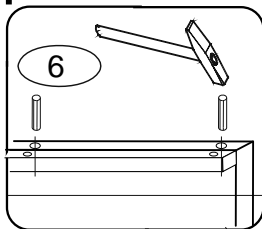

Kolíky vždy narazte nejprve do otvorů ve hranách dílců, je nutné je zarazit se stejným přesahem. V případě, že některý kolík přesahuje, je nutné jej zakrátit. Dílce srážejte kladivem pouze přes dřevěnou podložku.

