

DOMINO

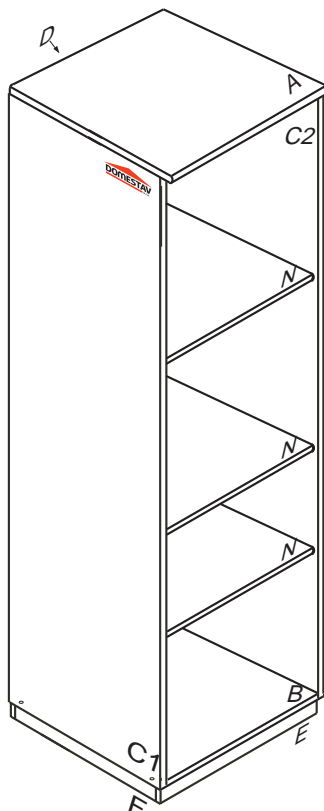







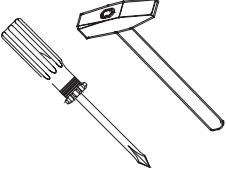

D307

330x306x690



Kolíky vždy narazte nejprve do otvorů ve hranách dílců, je nutné je zarazit se stejným přesahem. V případě, že některý kolík přesahuje, je nutné jej zakrátit. Dílce srážejte kladivem pouze přes dřevěnou podložku.

1/2

	 4 x1 4mm	 6 x6 8x35mm	 29 x8 4x40mm	 60 x6 15mm	 61 x6 DU 2
	 67 x6	 71 x4 7x50mm	 85 x12	 87 x4	 92 x40 1,4x20mm

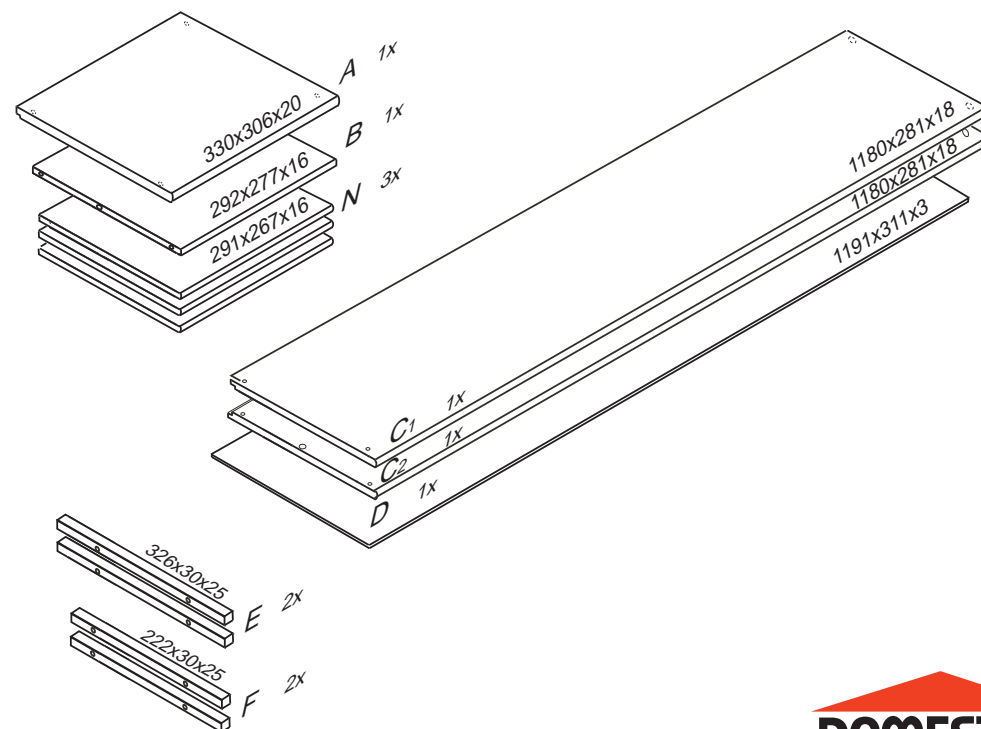

D 307

1

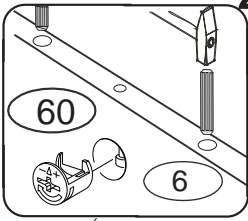

2

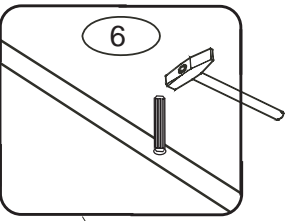

3

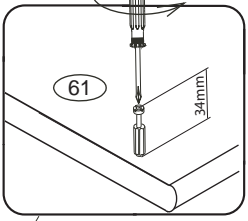

4

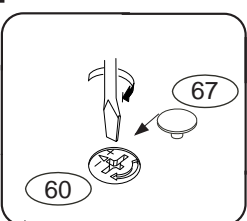

7

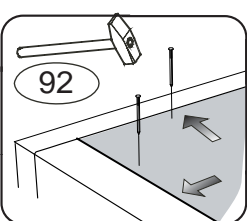

8

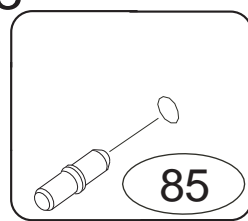

2/2

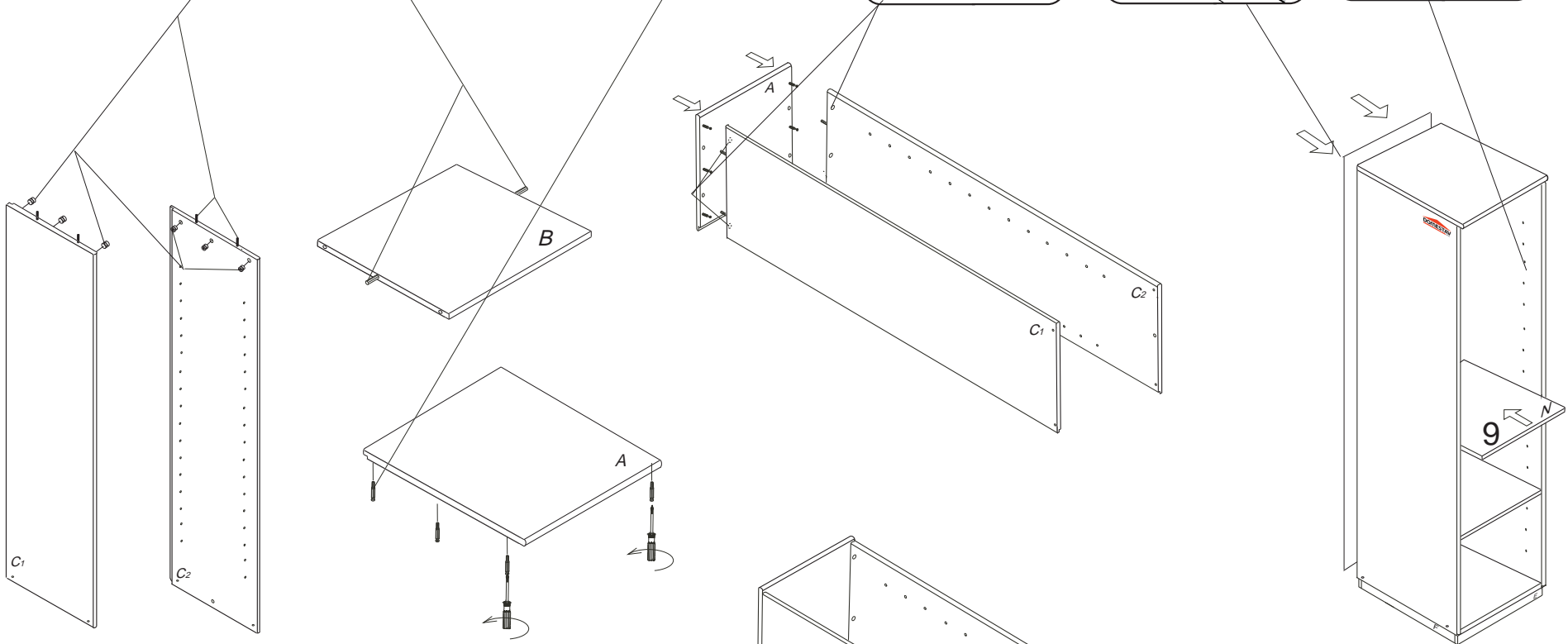

5

