

REMARK 90

č. 113

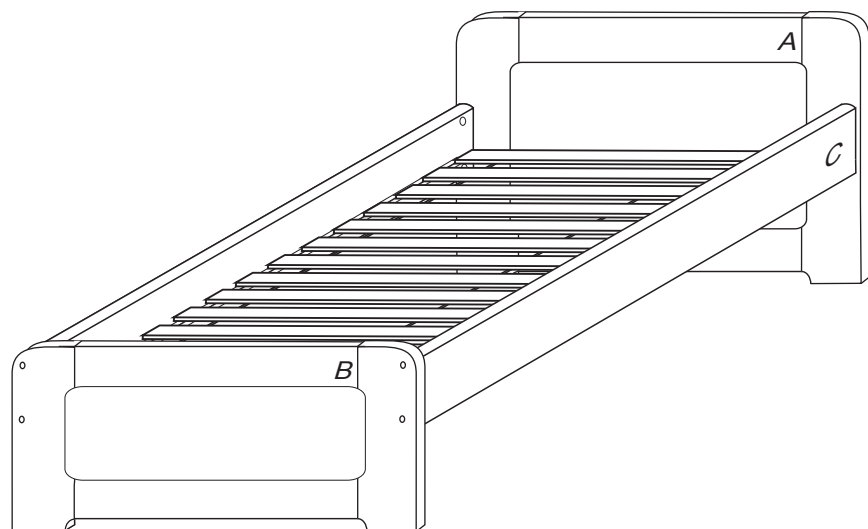

V případě vrzání vtlačte do spoje tekuté mýdlo v poměru 1:1 s vodou. Tento jev se u nábytku z masivu vyskytuje běžně.

1/2

	4 x1 č.4	9 x12 10x50mm			12 x8 6x80mm
	29 x8 4x40mm				

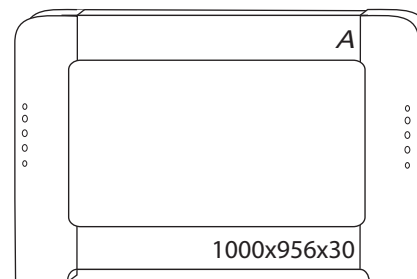

A 1x

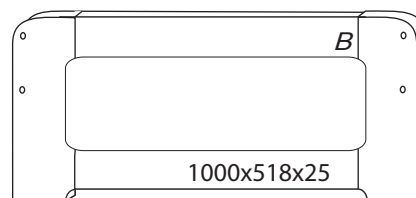

B 1x

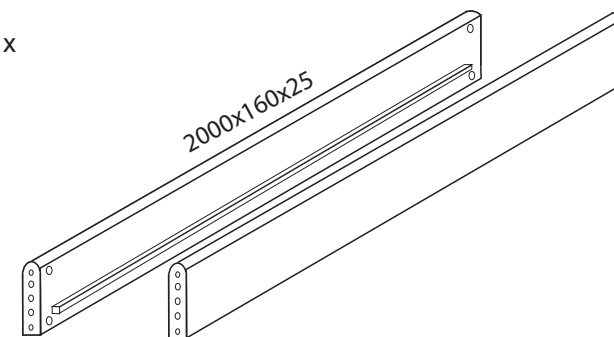

C 2x

1

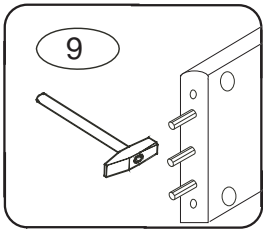

2

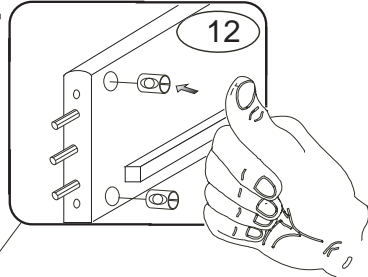

3

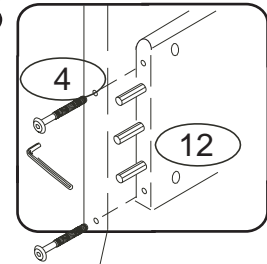

5

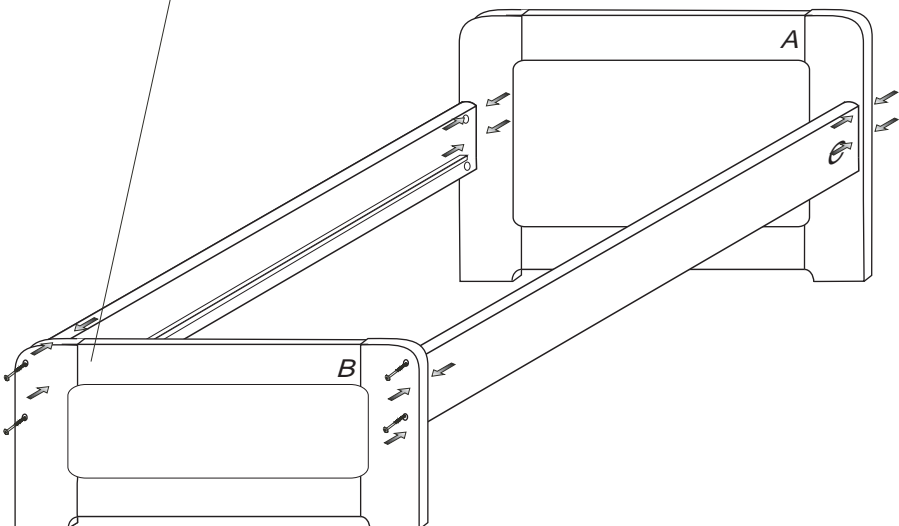
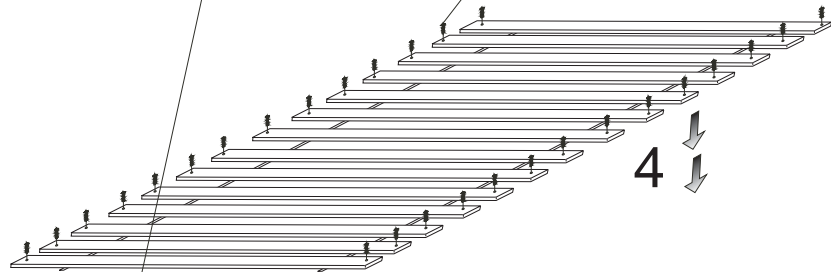
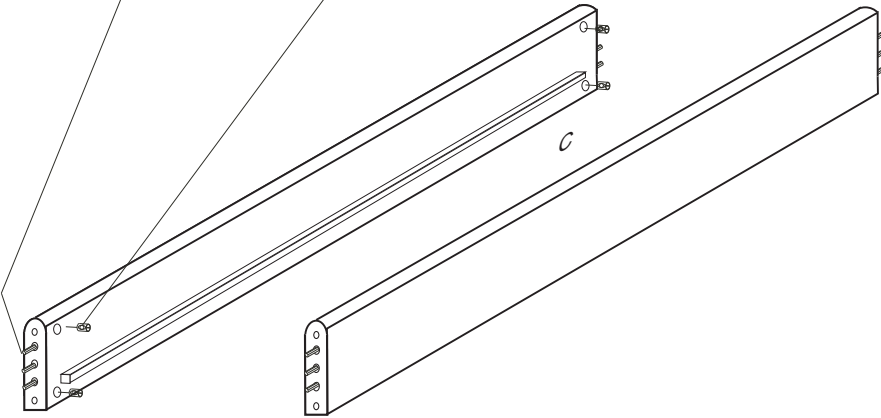
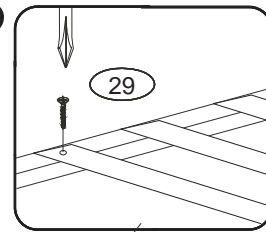

Kolíky vždy naražte nejprve do otvorů ve hranách dílců. Dílce srážejte kladivem pouze přes dřevěnou podložku.